

A HEAVY PICTURE WINDOW
HEADER DETAIL

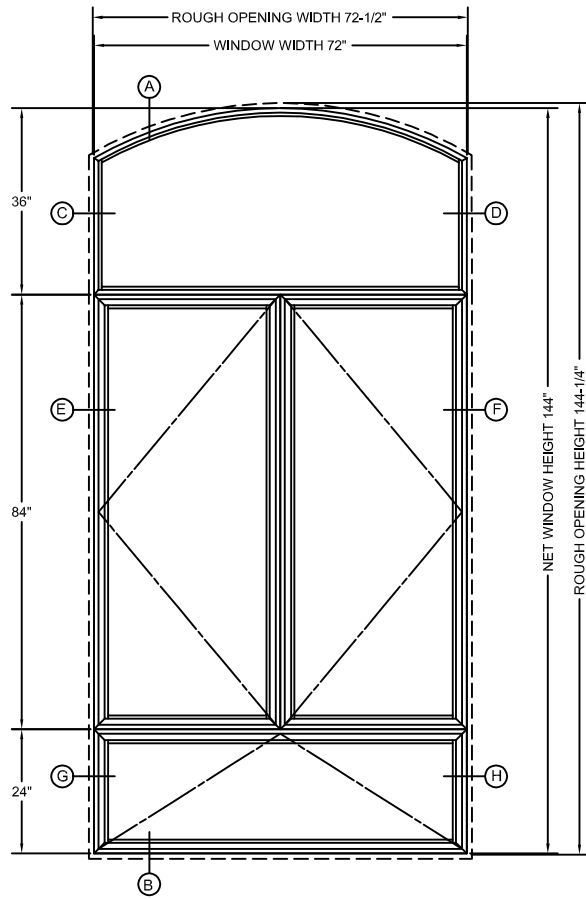

C HEAVY PICTURE WINDOW
LEFT JAMB DETAIL

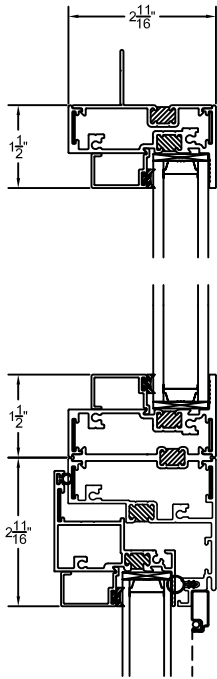
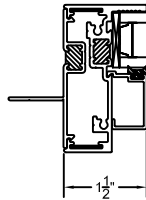

HEAVY PICTURE WINDOW
RIGHT JAMB DETAIL **D**

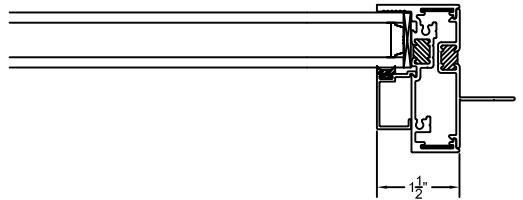

F CASEMENT WINDOW
HINGE JAMB DETAIL

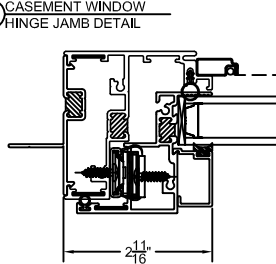

CASEMENT WINDOW
HINGE JAMB DETAIL **G**

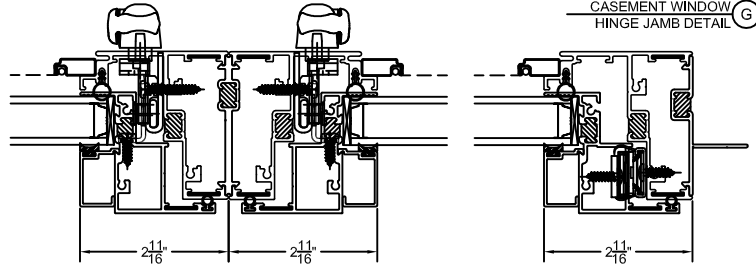

F CASEMENT WINDOW
HINGE JAMB DETAIL

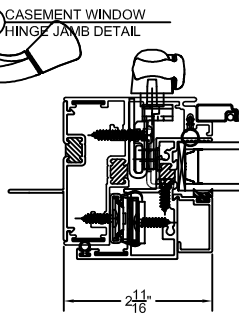

CASEMENT WINDOW
HINGE JAMB DETAIL **G**

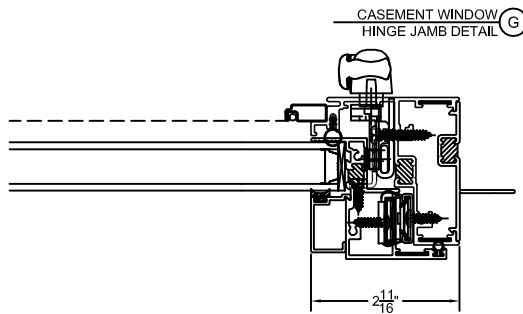

B AWNING WINDOW
SILL DETAIL

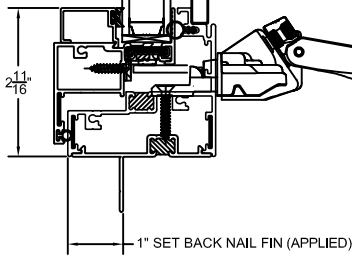

STANDARD TOLERANCES FOR EXTRUDED SHAPES APPLY UNLESS SPECIFICALLY SHOWN OTHERWISE



RAM INDUSTRIES
8600 COMMERCE PARK DR.
HOUSTON, TX 77036
PH: 281-495-9056
FX: 281-495-6778

**S800 HEAVY PICTURE WINDOW,
S900 CASEMENT, S990 AWNING**
MULLED COMBINATION