

A CASEMENT WINDOW
HEADER DETAIL

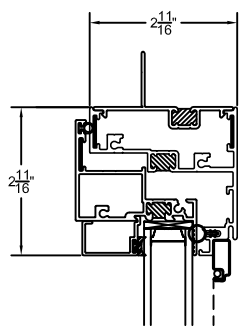

EXTERIOR

B FIXED CASEMENT WINDOW
HEADER DETAIL

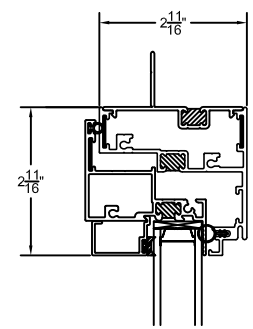

EXTERIOR

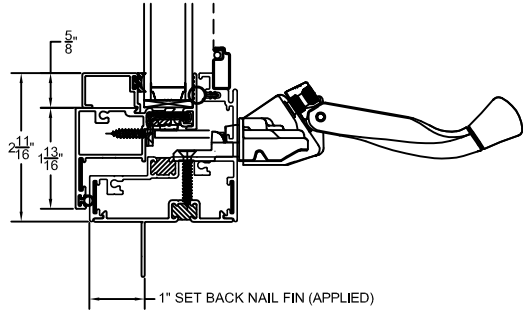

C CASEMENT WINDOW
SILL DETAIL

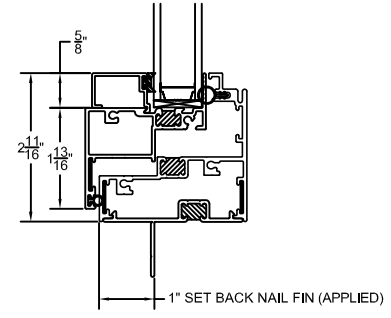

D FIXED CASEMENT WINDOW
SILL DETAIL

C CASEMENT WINDOW
HINGE JAMB DETAIL

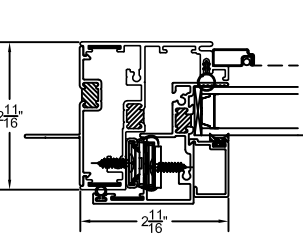

D CASEMENT WINDOW
LOCKING/FIXED JAMB DETAIL

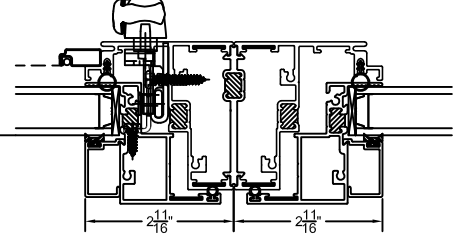

CASEMENT WINDOW
FIXED/LOCKING JAMB DETAIL **E**

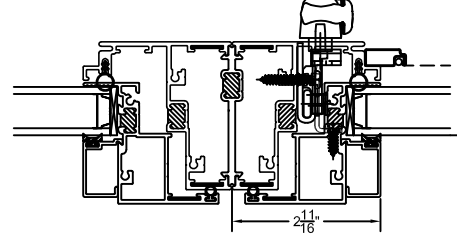

CASEMENT WINDOW **F**
HINGE JAMB DETAIL

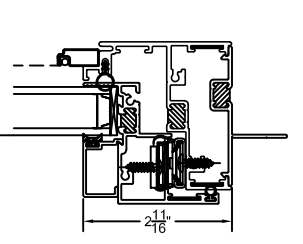

EXTERIOR

STANDARD TOLERANCES FOR EXTRUDED SHAPES APPLY UNLESS SPECIFICALLY SHOWN OTHERWISE



RAM INDUSTRIES
8600 COMMERCE PARK DR.
HOUSTON, TX 77036
PH: 281-495-9056
FX: 281-495-6778

S900 CASEMENT WINDOW

TRIPLE UNIT WITH FIXED CASEMENT